



FLYING EYE

# User Manual

## Propeller Guards

DJI Matrice 30



*Made in France*



[www.flyingeye.fr](http://www.flyingeye.fr)



# Summary

Description

01

Content

02

Installation

03

User Guide

08

Precautions

09

Support & Warranty

10



# Propeller Guards

## DJI Matrice 30

### Description

Propeller guards for the DJI Matrice 30 are essential safety accessories designed to protect the drone's propellers from collisions, while ensuring the safety of users and the environment during flight. They are particularly useful in confined environments or when the drone flies close to people, obstacles or delicate objects.

### Technical specifications :

- Dimensions: 39.5 x 26.5 x 8.5 cm
- Total weight: approx. 215 g
- Materials: Nylon and Carbon
- Color: Black

***Quick assembly and disassembly without tools***

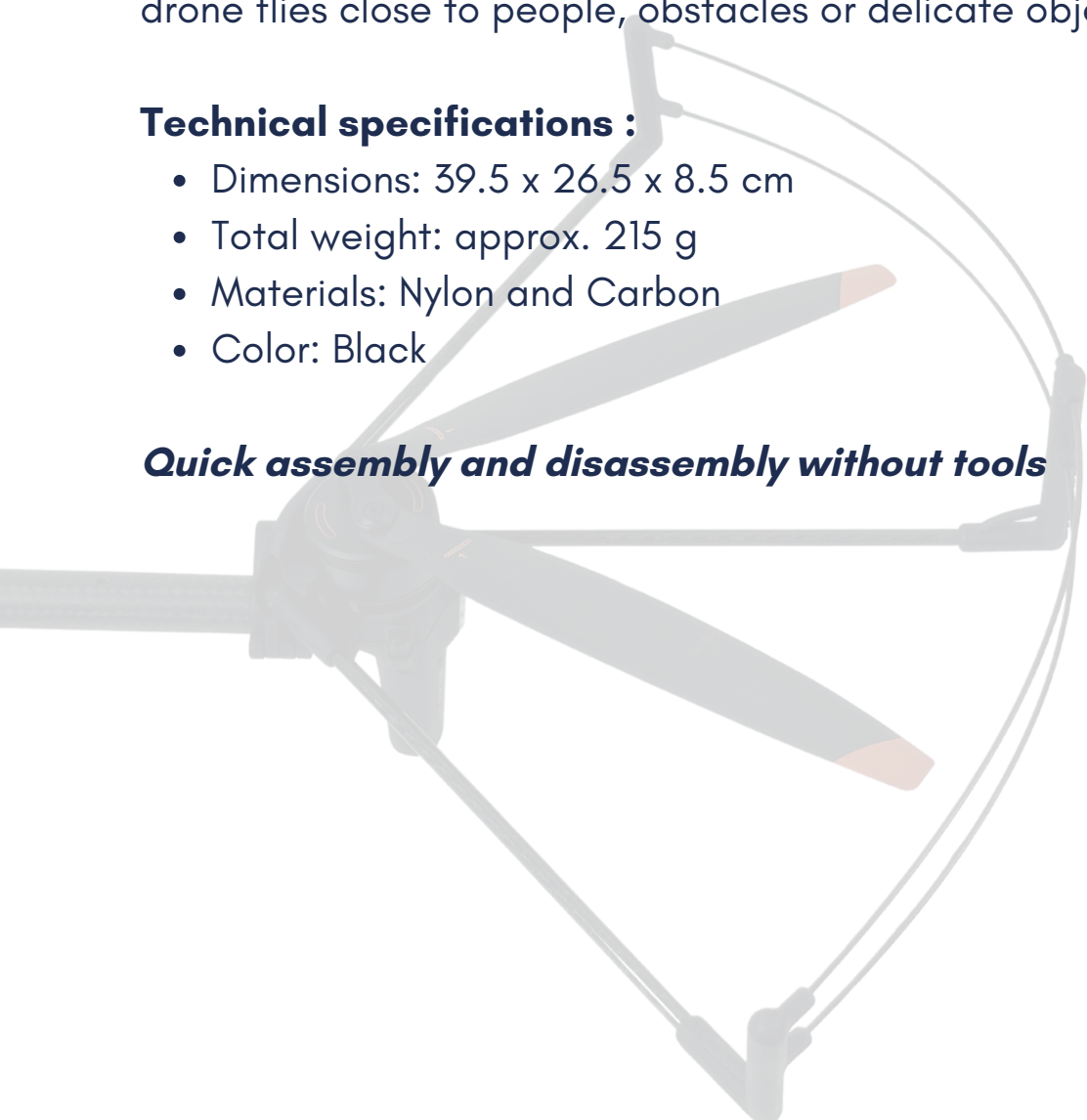



## Content

### Kit contents

- 4 x Propeller guards
- 4 x Mounting screws
- 1 x Installation manual

### Requirements

- **Compatibility:** This kit is specially designed for the DJI Matrice 30.
- Please ensure that you are using the correct accessories for this model of drone.
- **Propeller condition:** Before installing the guards, check the condition of the propellers. Replace any damaged propellers before fitting the guards, as damaged propellers can lead to flight problems.

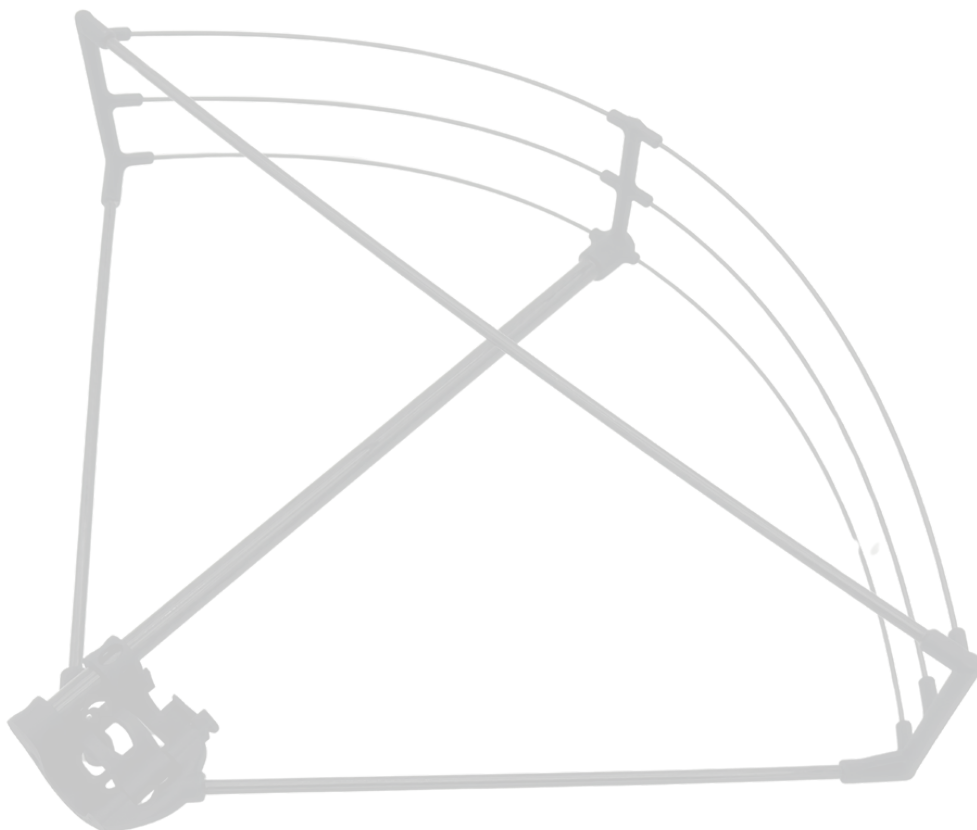



## Installation

### Preparing the drone:

- Make sure the drone is switched off and placed on a flat, stable surface.

### Mounting the guards :

- Attaching the guards: Use the quick-release fasteners to attach the propeller guards to each arm of the drone.
- Check tightening: Tighten the screws. Make sure the guards are firmly attached and do not move once installed.
- Check that each propeller turns freely and that the guards do not impede its movement.

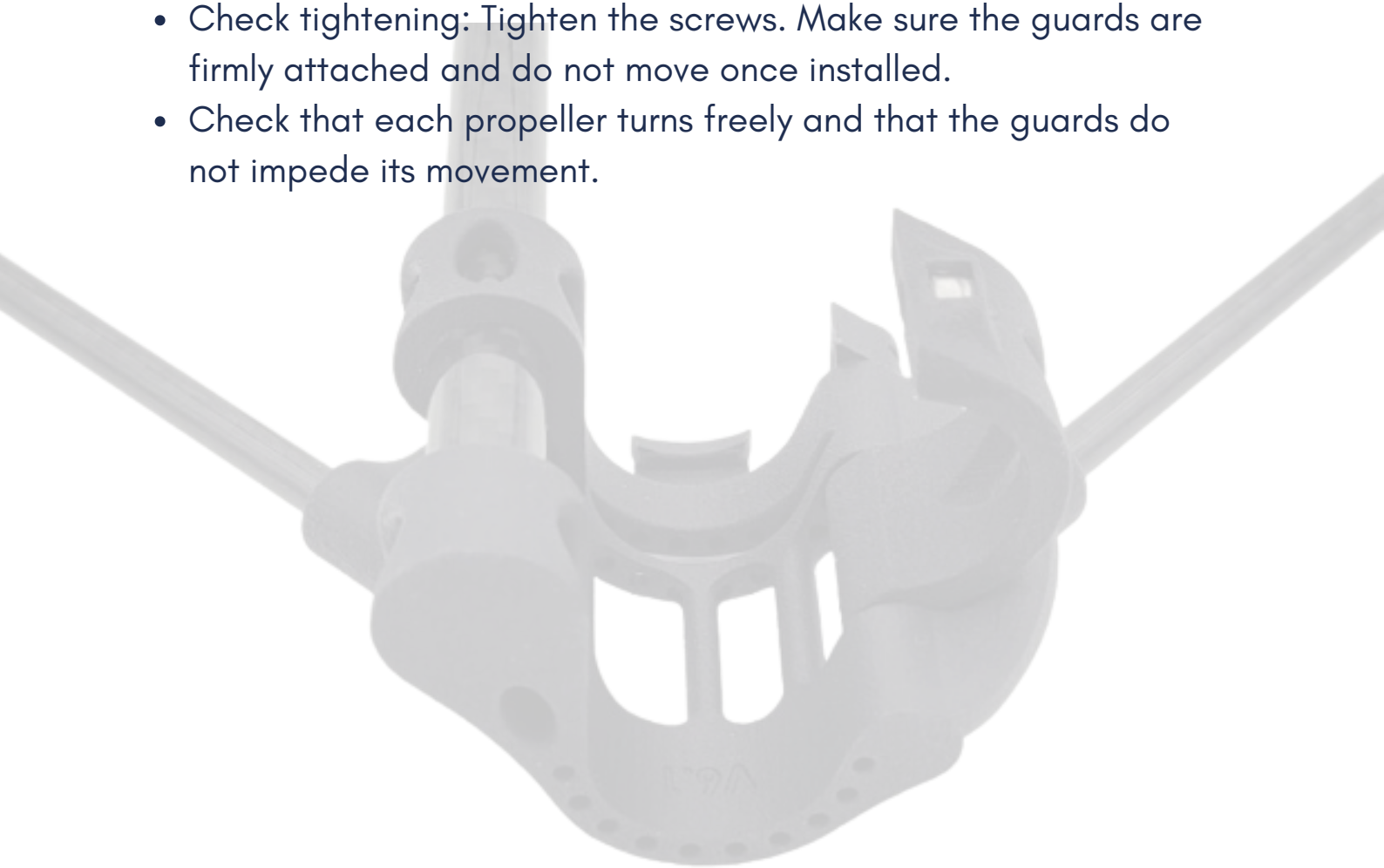



# Installation

## 1. Front propeller guard assembly



Unscrew



Spread the base

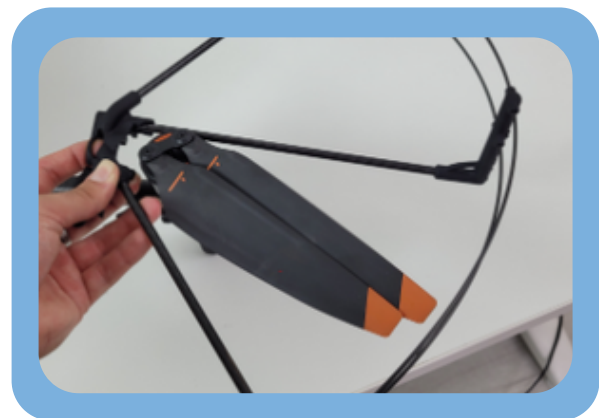

Insert propeller guard



## Installation



Insert propeller guard all the way in



Close the base



Screw



# Installation

## 2. Rear propeller guard assembly



Unscrew



Spread the base



Insert propeller guard from below





# Installation



Insert propeller guard all the way in



Close the base



Screw



## User guide

### **Pre-flight check :**

Before each flight, check that the propeller guards are securely fastened and show no cracks or signs of wear.

### **Maintenance and care**

#### *1.cleaning :*

After each flight, clean the propeller guards with a soft cloth to remove any accumulated dust or dirt. If flying in wet conditions, be sure to dry the guards thoroughly before storing.

#### *2.regular inspection :*

Inspect the protectors regularly for cracks, deformation or wear. If the protectors show signs of damage, replace them immediately to ensure optimum safety.

#### *3.storage :*

Store propeller guards in a dry place away from direct sunlight or extreme temperatures, which could damage them or alter their shape.

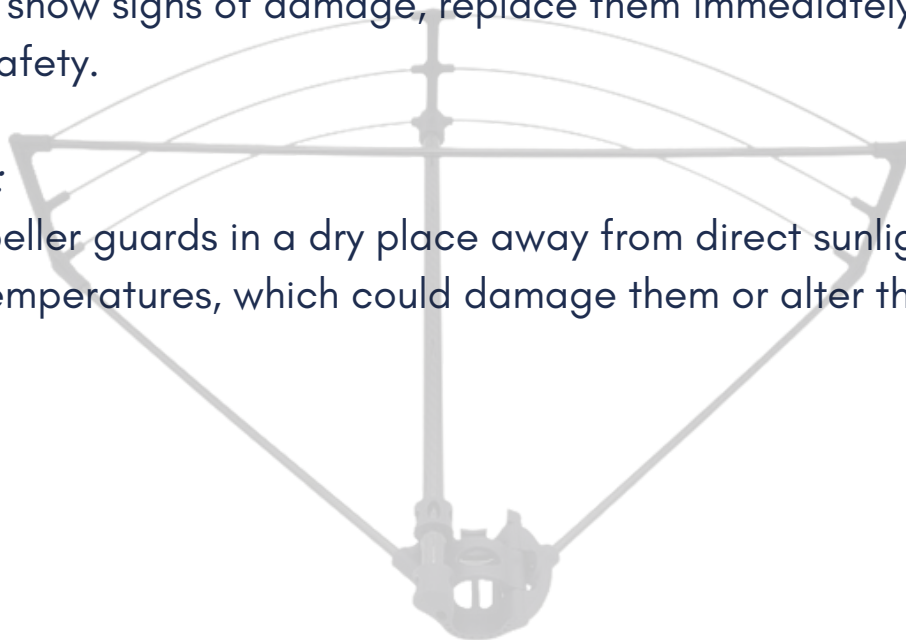



## Precautions

### Safety precautions

- **Reduced performance:** The addition of propeller guards can slightly affect the drone's flight performance, particularly flight time and battery consumption. Please take this into account when planning your missions.
- **Avoid high-speed flights:** Propeller guards can increase air resistance, especially at high speeds.
- **Watch for vibrations:** If you notice vibrations or instabilities during flight, land immediately and check that the propeller guards are secure and in good condition.

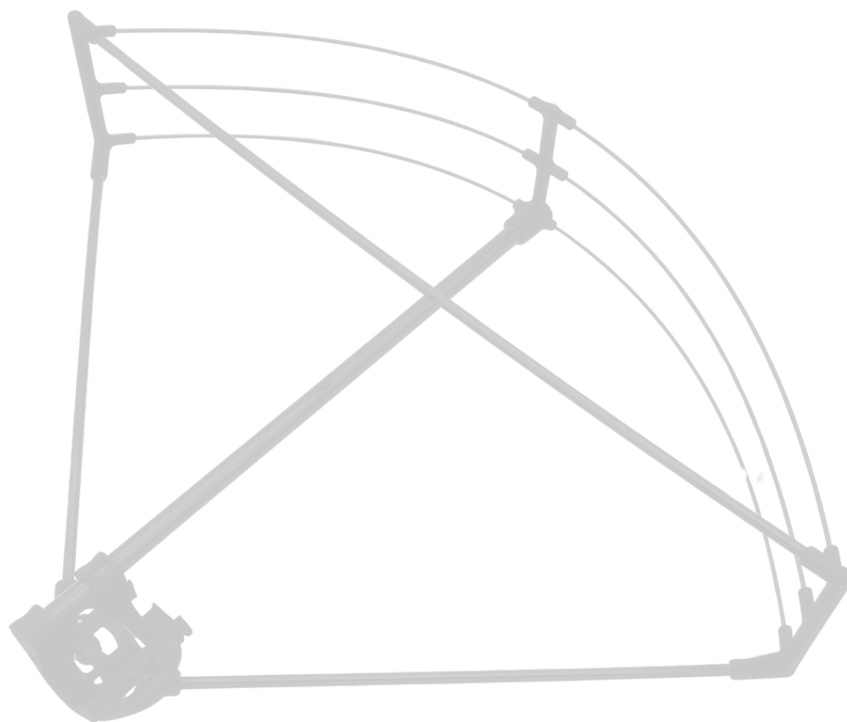



## Support & Warranty

### Technical support

If you encounter any difficulties during installation, or if you have any further questions about the use of propeller guards, please contact Flying Eye technical support.

### Warranty

Propeller guards for DJI Matrice 30 come with a 12-month warranty according to the conditions of purchase. The warranty covers manufacturing defects, but does not apply to damage caused by incorrect installation, accident or improper use.

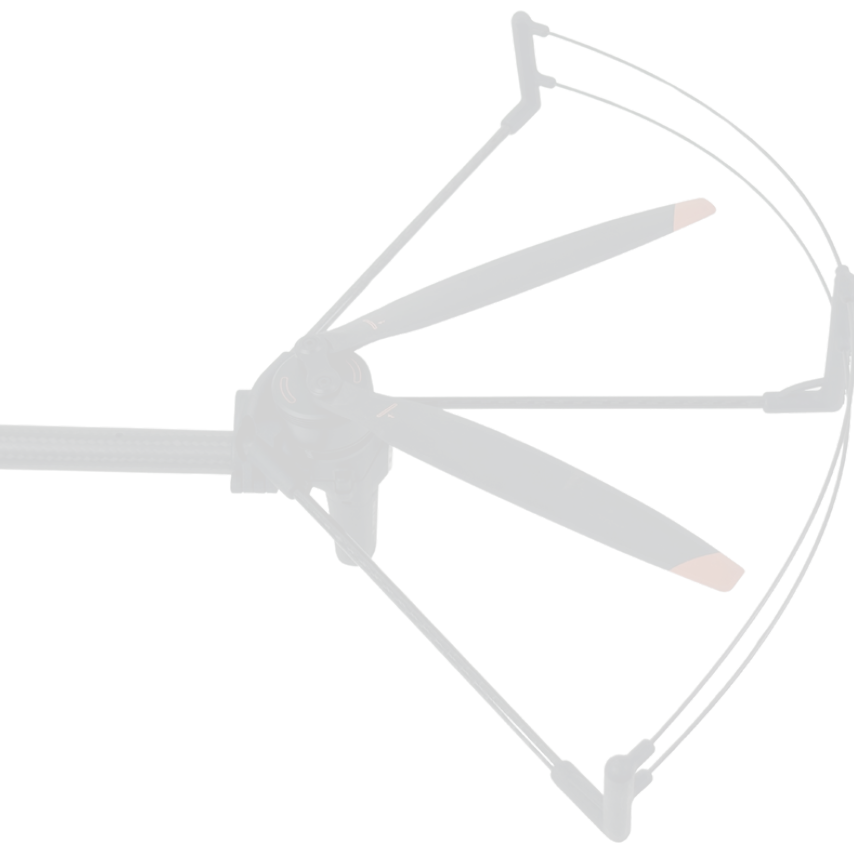



**FLYING EYE**

[WWW.FLYINGEYE.FR](http://WWW.FLYINGEYE.FR)

[INFO@FLYINGEYE.FR](mailto:INFO@FLYINGEYE.FR)

09.72.62.78.50

400 AVENUE ROUMANILLE  
GREEN SIDE - BATIMENT IB  
06410 BIOT / SOPHIA ANTIPOLIS